

Article number: 3311F195

Description: Gear Coupling FST195 without bore

## Measures

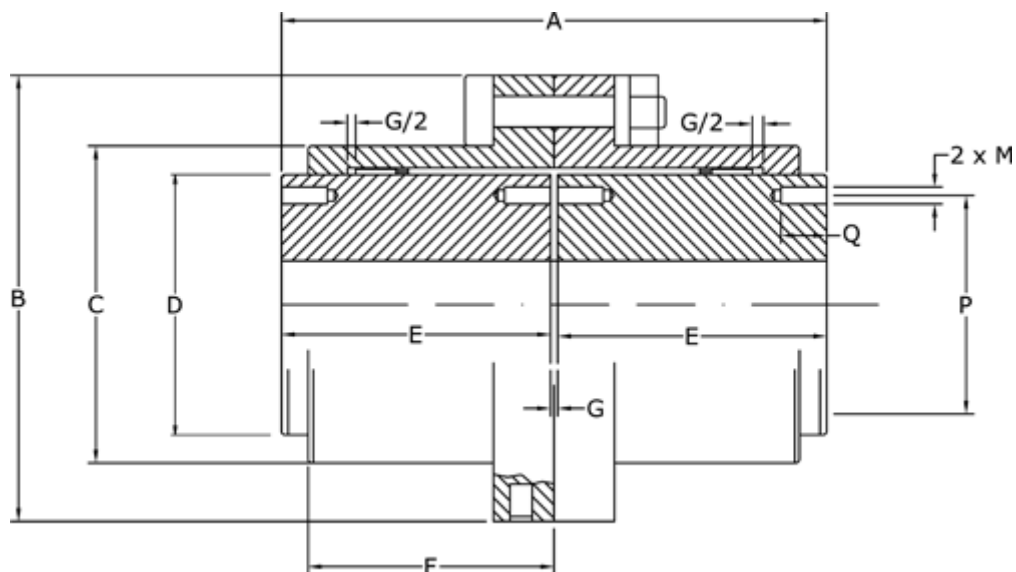

A = 308

B = 380

C = 307

D = 263

E = 150

F = 132.0

G = 8

M = M16

P = 226

Q = 24